

# set D

## Model D4

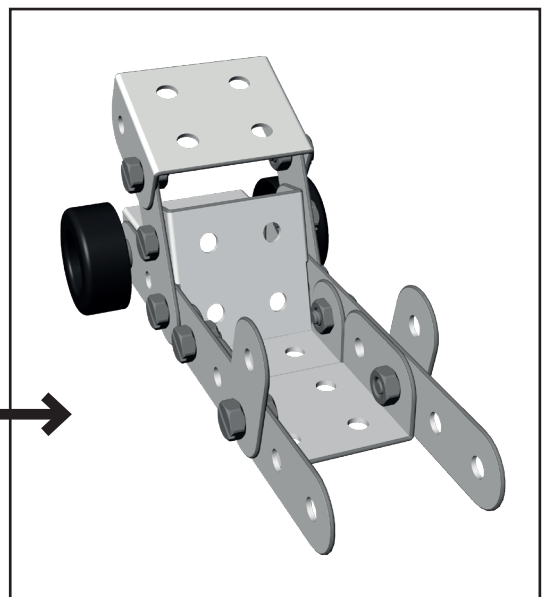

3.

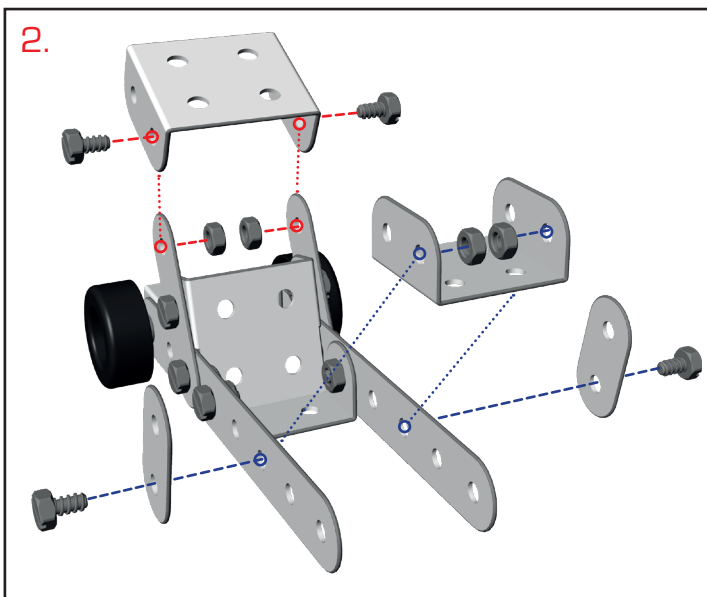
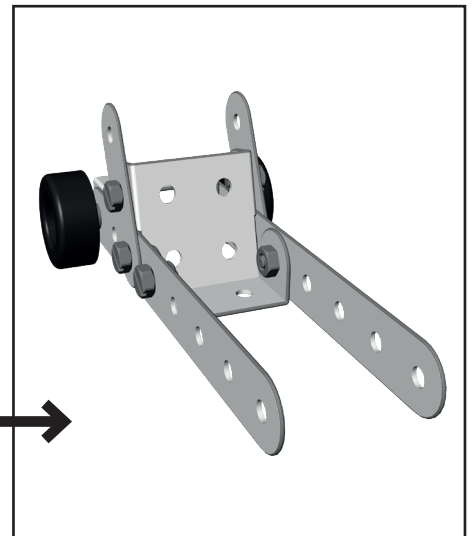
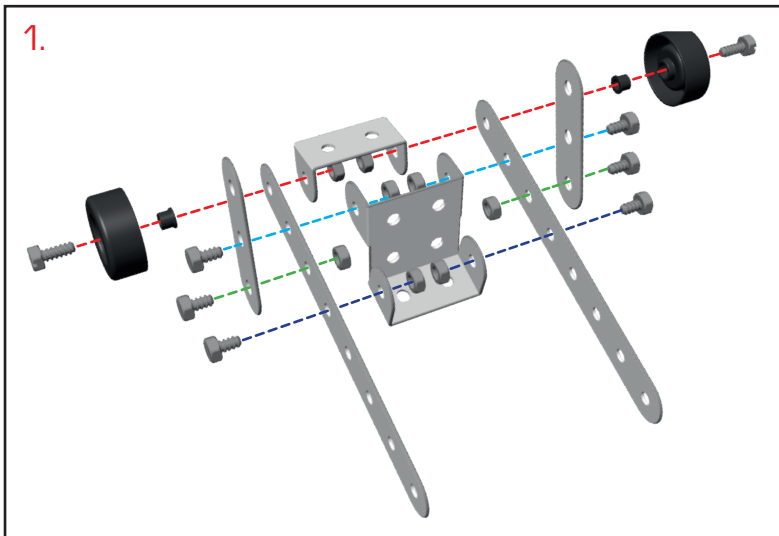
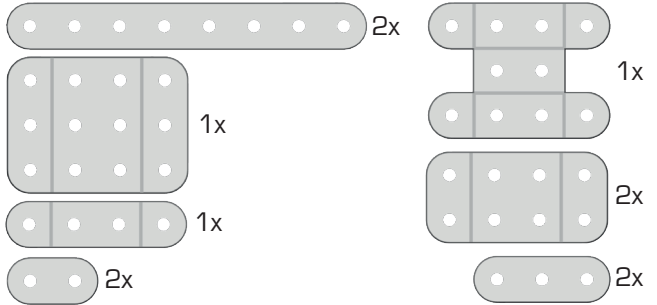
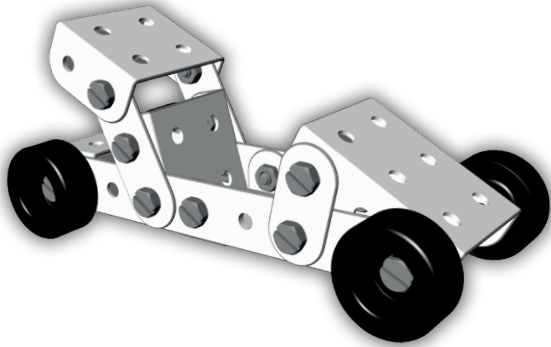