

# set D

## Model D5

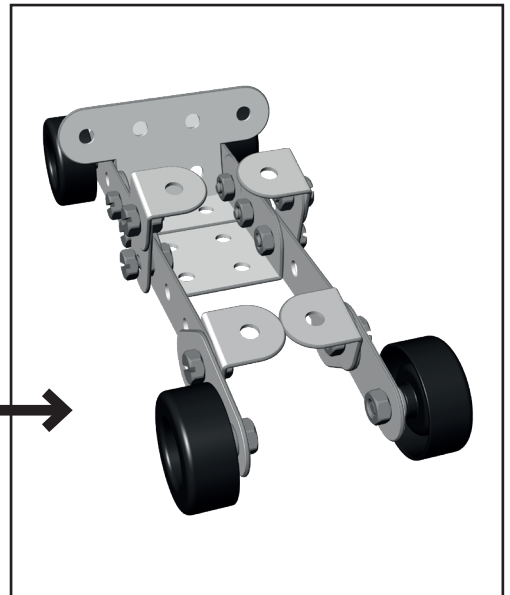

3.

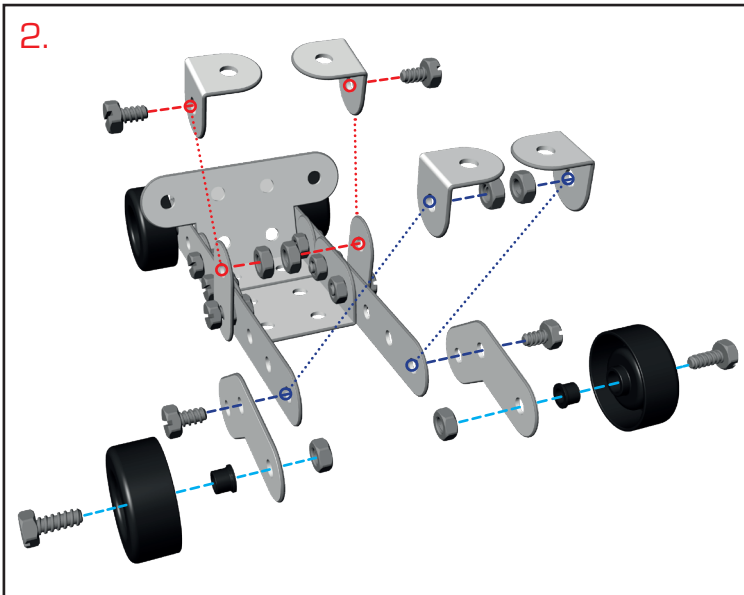
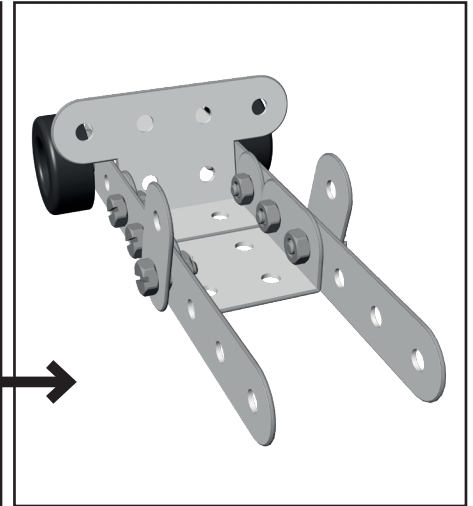
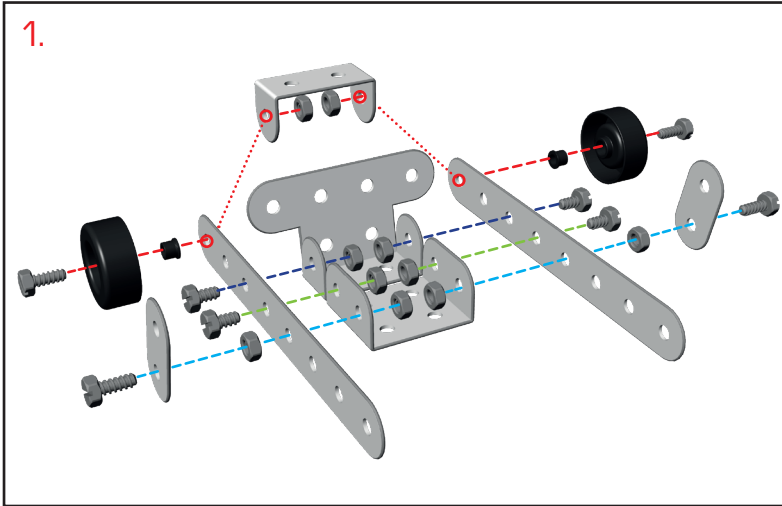
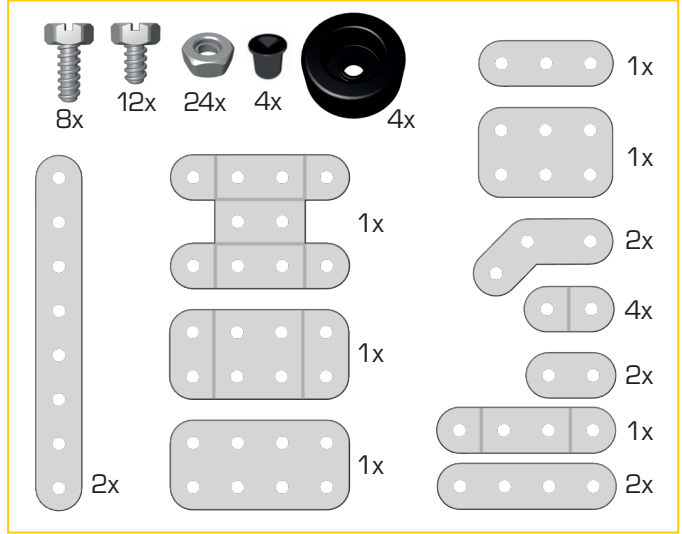